



## KIMBERLY-CLARK\* MIC-KEY\* Low-Profile Gastrostomy Feeding Tube



Helping your patient face the use of a gastrostomy tube, possibly for a lifetime, can be a challenge. That's why the KIMBERLY-CLARK\* MIC-KEY\* Low-Profile Gastrostomy Feeding Tube is designed to provide a little peace of mind for both of you.

The KIMBERLY-CLARK MIC-KEY Feeding Tube is available in 79 sizes for a comfortable, proper fit that minimizes the chance of leakage. The MIC-KEY feeding tube does not require the use of an obturator, so the tube does not need to be distorted for insertion. The slim design allows more air to circulate around the stoma and makes it easy to care for.

For active patients, the MIC-KEY feeding tube is less cumbersome than conventional gastrostomy tubes, and its low-profile design makes it unobtrusive and easier to conceal.

### Tube Features Include:

- Medical Grade Silicone Construction
- Low-Profile Design
- Tapered Distal Tip
- Silicone Internal Retention Balloon
- Distal Tip Recessed at Recommended Fill Volume
- Proximal Anti-Reflux Valve
- SECUR-LOK\* Extension Set Connector Mechanism
- Radiopaque Stripe
- Wide Variety of Extension Sets Available

The KIMBERLY-CLARK\* MIC-KEY\* Low-Profile Gastrostomy Feeding Tube is just one of the clinical solutions that you can depend on to meet the demands of your fast-paced world.

Whether your needs involve preventing healthcare-associated infections, surgical and digestive solutions or pain management, with Kimberly-Clark you'll always have one less worry.



**Kimberly-Clark**

*Trusted Clinical Solutions\**

# KIMBERLY-CLARK\* MIC-KEY\* feeding tubes provide a worry-free solution to enteral feeding

## 12 French

STOCK #	STOMA LENGTH
0120-12-0.8	0.8 cm
0120-12-1.0	1.0 cm
0120-12-1.2	1.2 cm
0120-12-1.5	1.5 cm
0120-12-1.7	1.7 cm
0120-12-2.0	2.0 cm
0120-12-2.3	2.3 cm
0120-12-2.5	2.5 cm
0120-12-2.7	2.7 cm
0120-12-3.0	3.0 cm
0120-12-3.5	3.5 cm
0120-12-4.0	4.0 cm

## 14 French

STOCK #	STOMA LENGTH
0120-14-0.8	0.8 cm
0120-14-1.0	1.0 cm
0120-14-1.2	1.2 cm
0120-14-1.5	1.5 cm
0120-14-1.7	1.7 cm
0120-14-2.0	2.0 cm
0120-14-2.3	2.3 cm
0120-14-2.5	2.5 cm
0120-14-2.7	2.7 cm
0120-14-3.0	3.0 cm
0120-14-3.5	3.5 cm
0120-14-4.0	4.0 cm
0120-14-4.5	4.5 cm
0120-14-5.0	5.0 cm

## 16 French

STOCK #	STOMA LENGTH
0120-16-0.8	0.8 cm
0120-16-1.0	1.0 cm
0120-16-1.2	1.2 cm
0120-16-1.5	1.5 cm
0120-16-1.7	1.7 cm
0120-16-2.0	2.0 cm
0120-16-2.3	2.3 cm
0120-16-2.5	2.5 cm
0120-16-2.7	2.7 cm
0120-16-3.0	3.0 cm
0120-16-3.5	3.5 cm
0120-16-4.0	4.0 cm
0120-16-4.5	4.5 cm
0120-16-5.0	5.0 cm

## 18 French

STOCK #	STOMA LENGTH
0120-18-0.8	0.8 cm
0120-18-1.0	1.0 cm
0120-18-1.2	1.2 cm
0120-18-1.5	1.5 cm
0120-18-1.7	1.7 cm
0120-18-2.0	2.0 cm
0120-18-2.3	2.3 cm
0120-18-2.5	2.5 cm
0120-18-2.7	2.7 cm
0120-18-3.0	3.0 cm
0120-18-3.5	3.5 cm
0120-18-4.0	4.0 cm
0120-18-4.5	4.5 cm
0120-18-5.0	5.0 cm

## 20 French

STOCK #	STOMA LENGTH
0120-20-0.8	0.8 cm
0120-20-1.0	1.0 cm
0120-20-1.2	1.2 cm
0120-20-1.5	1.5 cm
0120-20-1.7	1.7 cm
0120-20-2.0	2.0 cm
0120-20-2.3	2.3 cm
0120-20-2.5	2.5 cm
0120-20-2.7	2.7 cm
0120-20-3.0	3.0 cm
0120-20-3.5	3.5 cm
0120-20-4.0	4.0 cm
0120-20-4.5	4.5 cm
0120-20-5.0	5.0 cm

## 24 French

STOCK #	STOMA LENGTH
0120-24-1.5	1.5 cm
0120-24-1.7	1.7 cm
0120-24-2.0	2.0 cm
0120-24-2.3	2.3 cm
0120-24-2.5	2.5 cm
0120-24-2.7	2.7 cm
0120-24-3.0	3.0 cm
0120-24-3.5	3.5 cm
0120-24-4.0	4.0 cm
0120-24-4.5	4.5 cm
0120-24-5.0	5.0 cm

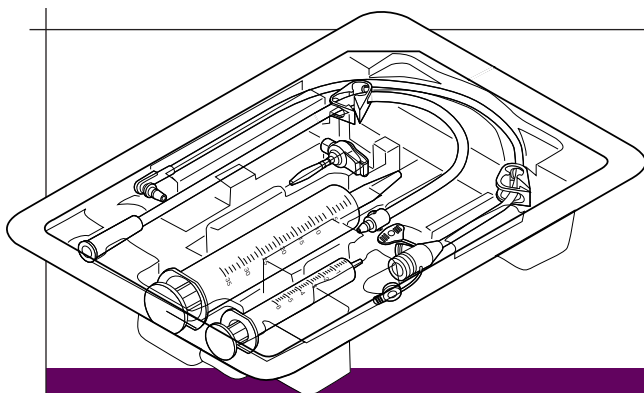

### Kit Includes†:

- 1- MIC-KEY\* Low-Profile Feeding Tube
- 1- MIC-KEY\* Extension Set with SECUR-LOK\* Right Angle Connector and 2 Port "Y" and Clamp – 12" Length (for continuous feeding)
- 1- MIC-KEY\* Bolus Extension Set with Cath Tip, SECUR-LOK\* Straight Connector and Clamp – 12" Length (for bolus feeding)
- 1- 6ml Syringe
- 1- 35ml Catheter Tip Syringe
- 4- Gauze Pads

## KIMBERLY-CLARK\* Mic-KEY\* Low-Profile Gastrostomy Feeding Tube

### Accessories

To complement the KIMBERLY-CLARK\* Mic-KEY\* Low-Profile Feeding Tube, a variety of feeding accessories and lengths are available for the continuous or bolus delivery of nutrients and medications. Each features the SECUR-LOK\* connection mechanism to minimize feeding set disconnects. In addition, each set allows for complete range of motion by allowing the Extension Set to rotate within the Mic-KEY\* feeding port during movement.

STANDARD STOCK #	DEHP-FREE FORMULATION STOCK #	LENGTH	DESCRIPTION	EACH
0221-12	0121-12	12"	Mic-KEY* Extension Set with SECUR-LOK* Right Angle Connector and 2 Port "Y" and Clamp	5
0221-24	0121-24	24"	Mic-KEY Extension Set with SECUR-LOK Right Angle Connector and 2 Port "Y" and Clamp	5
0222-02	0122-02	2"	Mic-KEY* Medication Set with SECUR-LOK* Right Angle Connector and 2 Port "Y"	5
0223-12	0123-12	12"	Mic-KEY* Bolus Extension Set with Cath Tip, SECUR-LOK Straight Connector and Clamp	5
0223-24	0123-24	24"	Mic-KEY Bolus Extension Set with Cath Tip, SECUR-LOK Straight Connector and Clamp	5
0224-12	0124-12	12"	Mic-KEY* Bolus Extension Set with Cath Tip, SECUR-LOK* Right Angle Connector and Clamp	5
0224-24	0124-24	24"	Mic-KEY Bolus Extension Set with Cath Tip, SECUR-LOK Right Angle Connector and Clamp	5
0226-12	0126-12	12"	Mic-KEY* Threaded Extension Set with SECUR-LOK* Right Angle Connector and Clamp (for International sale only)	5
0226-24	0126-24	24"	Mic-KEY Threaded Extension Set with SECUR-LOK Right Angle Connector and Clamp (for International sale only)	5
	0125-00		Mic-KEY* Stoma Measuring Device	10

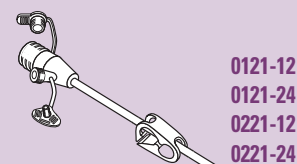

0121-12  
0121-24  
0221-12  
0221-24

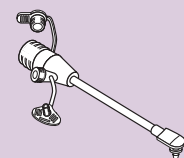

0122-02  
0222-02

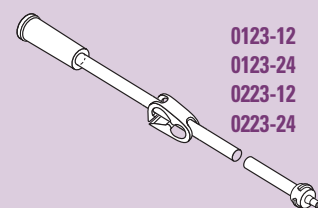

0123-12  
0123-24  
0223-12  
0223-24

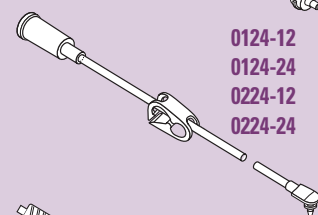

0124-12  
0124-24  
0224-12  
0224-24

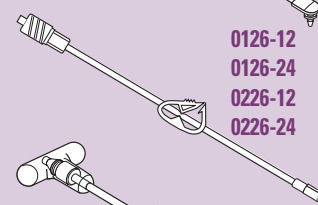

0126-12  
0126-24  
0226-12  
0226-24

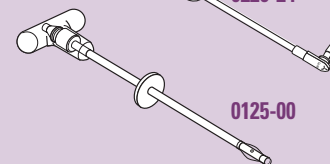

0125-00

For a complete listing of Digestive Health products and services, visit our website at [khealthcare.com](http://khealthcare.com) or [khealthcare.com/mic-key](http://khealthcare.com/mic-key), or contact your local sales rep at 1-800-528-5591 (U.S.), +1 801 572 6800 (Int.).

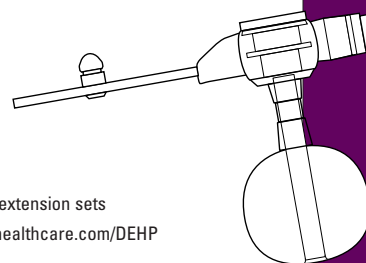

† All KIMBERLY-CLARK\* MIC-KEY\* Low-Profile Gastrostomy Feeding Tube Kits include DEHP-Free Formulation extension sets

‡ Standard formulation contains DEHP. For further information about DEHP, please visit our website at [www.khealthcare.com/DEHP](http://www.khealthcare.com/DEHP)

**KIMBERLY-CLARK\* MIC-KEY\***  
**Low-Profile Gastrostomy Feeding Tube**



**Commitment to Excellence**

If, for any reason, our products do not meet your expectations, please let us know your comments or suggestions for improvement. Your input will result in a concerted effort on our part to meet your requirements. Our goal is to provide quality products that completely meet your needs time after time.

**For more information, please call 1-800-528-5591 (U.S.), +1 801 572 6800 (Int.), ask your sales representative, or visit our web site at [www.kchealthcare.com/mic-key](http://www.kchealthcare.com/mic-key).**

\*Registered Trademark or Trademark of Kimberly-Clark Worldwide, Inc.  
© 2006 KCWW. All rights reserved.

KLM-556 H8429/Z0393-2



**Kimberly-Clark**

*Trusted Clinical Solutions\**